



99944200553

ProSweep Attachment

FOR MODELS: SRM-2400SB, 260SB, 261SB, PAS-2400, 2601, 230, 231, 260, 261, 265, 266, 280, 2620

Operator's Manual

WARNING



Users of this equipment risk injury to themselves and others if the unit is used improperly and/or safety precautions are not followed. ECHO provides an operator's manual. It must be read and understood for proper and safe operation. Failure to do so could result in serious injury.

Specifications, descriptions and illustrative material in this literature are as accurate as known at the time of publication, but are subject to change without notice. Illustrations may include optional equipment and accessories, and may not include all standard equipment.

TABLE OF CONTENTS

Introduction 3
 The Operator's Manual 3
Servicing Information 3
 Parts/Serial Number 3
 Service 3
 Echo Consumer Product Support 4
 Product Registration 4
 Additional or Replacement Manuals 4
Safety 4
 Manual Safety Symbols and Important Information 4
 International Symbols 5
 Personal Condition and Safety Equipment 6
 Equipment 11
Description 12
Contents 13
Assembly 13
 Gear Housing to Lower Drive Shaft Assembly 13
 Power Head Shaft/Lower Shaft Assembly 14
Operation 15
 Operating Techniques 15
Maintenance 17
 Skill Levels 17
 Maintenance Intervals 18
 Lubrication 18
 Brush Replacement 20
Storage 21
 Storage Hook Installation 22
Specifications 23
Product Registration 24
Notes 26

INTRODUCTION

Welcome to the ECHO family. This ECHO product was designed and manufactured to provide long life and on-the-job dependability. Read and understand this manual. You will find it easy to use and full of helpful operating tips and SAFETY messages.

The Operator’s Manual

Keep it in a safe place for future reference. Contains specifications and information for safety, operation, maintenance, storage and assembly specific to this product. Scan QR codes throughout the operator’s manual for more information.

SERVICING INFORMATION

Parts/Serial Number

Genuine ECHO Parts and Assemblies for your ECHO products are available only from an Authorized ECHO Dealer. When you do need to buy parts always have the Model Number and Serial Number of the unit with you. You can find these numbers on the engine housing. For future reference write them in the space provided below.

Model No. _____

Serial No. _____



Service

Service of this product during the warranty period must be performed by an Authorized ECHO Service Dealer. For the name and address of the Authorized ECHO Service Dealer nearest you, ask your retailer or call: 1-800-432-ECHO (3246). Dealer information is also available on our Web Site. www.echo-usa.com. When presenting your unit for Warranty service/repairs, proof of purchase is required.

Echo Consumer Product Support

If you require assistance or have questions concerning the application, operation, or maintenance of this product, call the ECHO Consumer Product Support Department at 1-800-673-1558 from 8:00 am to 5:00 pm (Central Standard Time) Monday through Friday. Before calling, please know the model and serial number of your unit.

Product Registration

Register your ECHO equipment on-line at www.echo-usa.com or by filling out the product registration sheet included in this manual. Registering your product confirms warranty coverage and provides a direct link to ECHO if we find it necessary to contact you.

Additional or Replacement Manuals

Replacement Operator or Safety Manuals, and Parts Catalogs, are available from your Authorized ECHO Service Dealer, or at www.echo-usa.com, or by contacting ECHO Inc., 400 Oakwood Road, Lake Zurich, IL 60047 (800-673-1558). Always check www.echo-usa.com for updated information.



Safety Videos are available from your Authorized ECHO Service Dealer. A \$5.00 shipping charge is required for each video.

SAFETY

Manual Safety Symbols and Important Information

Throughout this manual and on the product itself, you will find safety alerts and helpful, informational messages preceded by symbols or key words. The following is an explanation of those symbols and key words and what they mean to you.

DANGER

The safety alert symbol accompanied by the word “DANGER” calls attention to an act or condition which WILL lead to serious personal injury or death if not avoided.

! WARNING

The safety alert symbol accompanied by the word “WARNING” calls attention to an act or condition which CAN lead to serious personal injury or death if not avoided.

! CAUTION

The safety alert symbol accompanied by the word “CAUTION” calls attention to an act or condition which may lead to minor or moderate personal injury if not avoided.

NOTICE

The enclosed message provides information necessary for the protection of the unit.

Note: This enclosed message provides tips for use, care and maintenance of the unit.











CIRCLE AND SLASH SYMBOL

This symbol means the specific action shown is prohibited. Ignoring these prohibitions can result in serious or fatal injury.

International Symbols

Symbol	Description	Symbol	Description
	Warning, see Operator’s Manual.		Safety/Alert
	Wear eye, ear and head protection.		Finger Severing
	Wear hand and foot protection.		Rotating Cutting Attachment
	Wear face shield.		Wear slip resistant foot wear.

Symbol	Description	Symbol	Description
	Keep feet away from blade.		Do not operate closer than 15 m (50 ft.) from electrical hazards. Keep bystanders at least 15 m (50 ft.) away.
	DO NOT USE BLADES - Line Head Only		Thrown Objects
	Plan retreat path from falling objects.		Hot Surface
		<p>AVOID KICKOUT Keep bystanders at least 15 m (50 ft.) away.</p> <p>Beware of thrown objects, wear eye protection.</p>	
		<p>Keep bystanders and helpers at least 15 m (50 ft.) away.</p>	

Personal Condition and Safety Equipment

! WARNING

Users of this product risk injury to themselves and others if the unit is used improperly and/or safety precautions are not followed. Proper clothing and safety gear must be worn when operating unit.

Physical Condition

Your judgment and physical dexterity may not be good:

- If you are tired or sick.
- If you are taking medication.

- If you have taken alcohol or drugs.

Operate unit only if you are physically and mentally well.

Eye Protection

WARNING

- ◆ **Eye protection that meets ANSI Z87.1 or CE requirements must be worn whenever you operate the unit.**
- ◆ **For additional safety, a full-face shield may be worn over safety glasses or goggles to provide protection from sharp branches or flying debris.**

Hand Protection

Wear sturdy, no-slip, rubber work gloves to improve your grip on the handles. Gloves also provide protection against cuts and scratches, cold environments, and reduce the transmission of machine vibration to your hands.

Hearing/Ear Protection

ECHO recommends wearing hearing protection whenever unit is used.

Breathing Protection

Operators who are sensitive to dust or other common airborne allergens may need to wear a dust mask to prevent inhaling these materials while operating unit. Dust masks can provide protection against dust, plant debris, and other plant matter such as pollen. Make sure the mask does not impair your vision, and replace the mask as needed to prevent air restrictions.

Proper Clothing

Wear snug-fitting, durable clothing:

- Pants should have long legs, shirts should have long sleeves.
- DO NOT WEAR SHORTS.
- DO NOT WEAR TIES, SCARVES, JEWELRY, or clothing with loose or hanging items that could become entangled in moving parts or surrounding growth.
- Keep clothing buttoned or zipped, and keep shirt tails tucked in.

Wear sturdy work shoes with nonskid rubber soles:

- DO NOT WEAR OPEN TOED SHOES.

- DO NOT OPERATE UNIT BAREFOOTED.

Keep long hair away from engine and air intake. Retain hair with cap or net.

Heavy protective clothing can increase operator fatigue, which may lead to heat stroke. Schedule heavy work for early morning or late afternoon hours when temperatures are cooler.

WARNING

The components of this machine generate an electromagnetic field during operation, which may interfere with some pacemakers. To reduce the risk of serious or fatal injury, persons with pacemakers should consult with their physician and the pacemaker manufacturer before operating this machine. In the absence of such information, ECHO does not recommend the use of this machine by anyone who has a pacemaker.

Extended Operation / Extreme Conditions

CAUTION

Prolonged exposure to cold and/or vibration may result in injury. Read and follow all safety and operation instructions to minimize risk of injury. Failure to follow instructions may result in painful wrist/hand/arm injuries.

It is believed that a condition called Raynaud's Phenomenon, which affects the fingers of certain individuals, may be brought about by exposure to vibration and cold. Exposure to vibration and cold may cause tingling and burning sensations, followed by loss of color and numbness in the fingers. The following precautions are strongly recommended, because the minimum exposure, which might trigger the ailment, is unknown.

- Keep your body warm, especially the head, neck, feet, ankles, hands, and wrists.
- Maintain good blood circulation by performing vigorous arm exercises during frequent work breaks, and also by not smoking.
- Limit the hours of operation. Try to fill each day with jobs where operating the unit or other hand-held power equipment is not required.
- If you experience discomfort, redness, and swelling of the fingers followed by whitening and loss of feeling, consult your physician before further exposing yourself to cold and vibration.

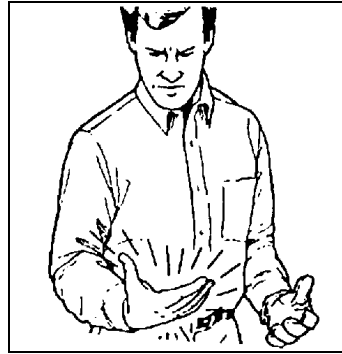

Repetitive Stress Injuries (RSI)

It is believed that overusing the muscles and tendons of the fingers, hands, arms, and shoulders may cause soreness, swelling, numbness, weakness, and extreme pain in those areas. Certain repetitive hand activities may put you at a high risk for developing a Repetitive Stress Injury (RSI). An extreme RSI condition is Carpal Tunnel Syndrome (CTS), which could occur when your wrist swells and squeezes a vital nerve that runs through the area. Some believe that prolonged exposure to vibration may contribute to CTS. CTS can cause severe pain for months or even years.

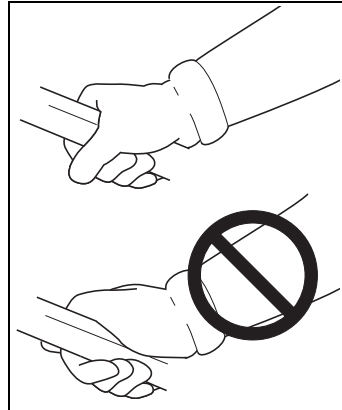

To reduce the risk of RSI/CTS, do the following:

- Avoid using your wrist in a bent, extended, or twisted position. Instead try to maintain a straight wrist position. Also, when grasping, use your whole hand, not just the thumb and index finger.
- Take periodic breaks to minimize repetition and rest your hands.
- Reduce the speed and force with which you do the repetitive movement.
- Do exercises to strengthen the hand and arm muscles.

- Immediately stop using all power equipment and consult a doctor if you feel tingling, numbness, or pain in the fingers, hands, wrists, or arms. The sooner RSI/CTS is diagnosed, the more likely permanent nerve and muscle damage can be prevented.

DANGER

All over head electrical conductors and communications wires can have electricity flow with high voltages. This unit is not insulated against electrical current. Never touch wires directly or indirectly, otherwise serious injury or death may result.

DANGER

Do not operate this product indoors or in inadequately ventilated areas. Engine exhaust contains poisonous emissions and can cause serious injury or death.

Read the Manuals

- Provide all users of this equipment with the Operator's Manual and Safety Manual for instructions on Safe Operation.

Clear the Work Area

- Spectators and fellow workers must be warned, and children and animals prevented from coming nearer than 15 m (50 ft.) while the unit is in use.

Keep a Firm Grip

- Always hold throttle handle and support handle with thumbs and fingers tightly encircling the handles.

Keep a Solid Stance

- Maintain footing and balance at all times. Do not stand on slippery, uneven or unstable surfaces. Do not work in odd positions or on ladders. Do not over reach.

Avoid Hot Surfaces

- During operation, the drive shaft housing and attachment bearing housing may become very hot, too hot to touch. Avoid contact during and immediately after operation.



Equipment

 **WARNING**

Use this attachment with ECHO approved models only. Serious injury may result from the use of this attachment combined with a non approved ECHO product.

- Check unit for loose/missing nuts, bolts, and screws. Tighten and/or replace as needed.
- Inspect ProSweep brushes for damage and that they are firmly secured in place. Replace brushes if damaged or missing.
- Check that the ProSweep attachment is firmly attached and in safe operating condition.

Note: ECHO, INC. will not be responsible for the failure of cutting devices, attachments or accessories which have not been tested and approved by ECHO.

 **WARNING**

Moving parts can amputate fingers or cause severe injuries. Keep hands, clothing and loose objects away from all openings.

- ◆ ***ALWAYS stop engine, disconnect spark plug, and make sure all moving parts have come to a complete stop before removing obstructions, clearing debris, or servicing unit.***
- ◆ ***DO NOT start or operate unit unless all guards and protective covers are properly assembled to unit.***
- ◆ ***NEVER reach into any opening while the engine is running. Moving parts may not be visible through openings.***

DESCRIPTION

Locate the safety decal(s) on your unit. Make sure the decal(s) is legible and that you understand and follow the instructions on it. If a decal cannot be read, a new one can be ordered from your ECHO dealer.

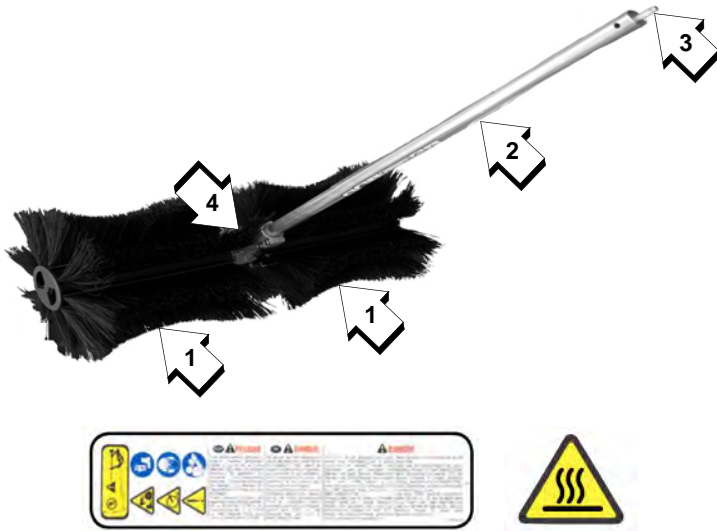

1. **BRUSHES** - Permanently attached to drum holders and come standard with 0.5 mm (0.018 in.) diameter nylon bristles. Optional 0.7 mm (0.028 in.) diameter brushes are available for fine material sweeping application.
2. **LOWER DRIVE SHAFT ASSEMBLY** - Included separately in the carton and must be assembled to the gear housing assembly. The lower driver shaft assembly contains the flexible drive cable, the outer shaft housing, and safety decal.
3. **FLEXIBLE DRIVE CABLE** - Cable end fits into drive shaft coupler of Pro Attachment Series or Split Boom models.
4. **BRUSH GEAR HOUSING ASSEMBLY** - Brushes come pre-assembled to the gear housing in the carton. Brushes rotate towards the operator viewed from the operators position.

CONTENTS

The ECHO product you purchased has been factory pre-assembled for your convenience. Due to packaging restrictions, some assembly may be necessary.

After opening the carton, check for damage. Immediately notify your retailer or ECHO Dealer of damaged or missing parts. Use the contents list to check for missing parts.

___ 1 - Brush and Gear Housing Assembly

___ 1 - Lower Driveshaft Assembly

___ 1 - Operator's Manual

___ 1 - Storage Hook Assembly

ASSEMBLY

Gear Housing to Lower Drive Shaft Assembly

WARNING

Do not perform maintenance or assembly procedures with engine running.

Parts Required: ProSweep Gear Housing, Lower Drive Shaft Assembly, PAS or SRM-SB Power Head (with shaft and coupling)

1. Remove vinyl caps from attachment drive shaft.
2. Place brush gear housing assembly on a flat surface with gear housing shaft mount at 45° angle.

3. Remove gear housing locator screw (A) with 4 mm hex wrench.
4. Loosen gear housing mounting bolt (B) with 5 mm hex wrench.
5. Position lower drive shaft (end without serial number decal) into gear housing shaft mount.
6. Align hole in drive shaft housing (C) with gear housing shaft hole (D) and seat lower drive shaft end into gear housing shaft mount. Install and tighten the gear housing locator screw.
7. Tighten the gear housing mounting bolt.

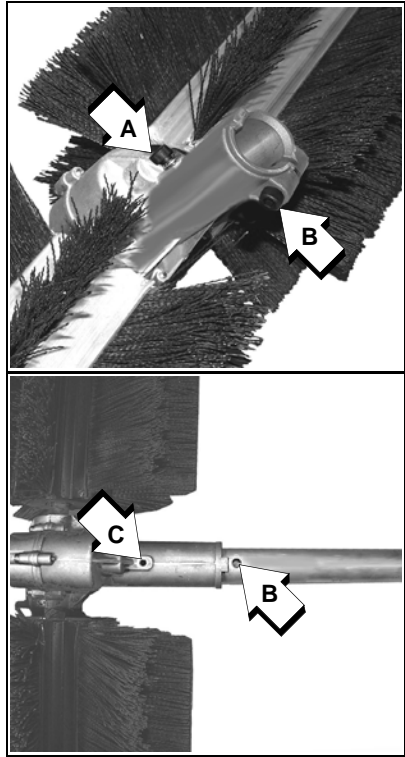

Power Head Shaft/Lower Shaft Assembly

WARNING

Do not perform maintenance or assembly procedures with engine running.

Parts Required: PAS or SRM-SB Power Head w/Shaft & Coupling

1. Set Power Head/Shaft Assembly on a level surface.
2. Pull locator pin (A) out, and turn counter-clockwise 1/4 turn to lock-out position.
3. Remove vinyl cap from attachment drive shaft.
4. Remove cardboard spacer, if necessary.



Note: Your coupler may appear different than coupler shown.

- Carefully fit attachment drive shaft assembly into coupler (B) to decal assembly line (C), making sure that the inner lower drive shaft engages the square upper drive shaft socket.

Note: Earlier model Power Heads may have shorter couplings.

Note: Lower bearing housing and head assembly must be in line with the engine.

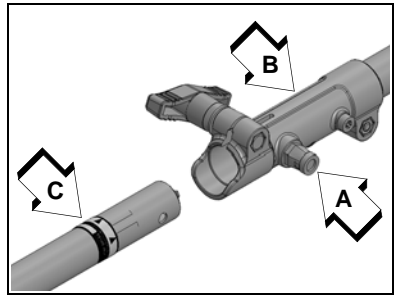

- Rotate locator pin (A) ¼ turn clockwise to engage lower shaft hole. Insure locator pin is fully engaged by twisting lower drive shaft. Locator pin should snap flush in coupler. Full engagement will prevent further shaft rotation.
- Secure lower shaft assembly to coupler by tightening clamping knob (D).

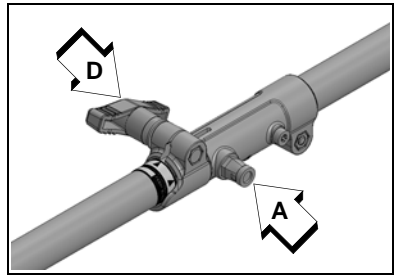

OPERATION

! WARNING

Moving parts can amputate fingers or cause severe injuries. Keep hands, clothing and loose objects away from all openings. Always stop engine, disconnect spark plug, and make sure all moving parts have come to a complete stop before removing obstructions, clearing debris, or servicing unit. Allow unit to cool before performing service.

Note: Refer to your Pro Attachment Series or Split Boom Operator's Manuals for correct engine fueling, starting and stopping instructions.

Operating Techniques

- Hold unit on your right side resting sweeper brushes on work surface.
- Firmly grasp throttle grip with right hand and front handle with left hand.

3. Position ProSweep at an angle to the work surface well out in front of your body.



WARNING

The sweeper brushes rotate towards the operator. Do not operate ProSweep at an angle with brushes close to your body which could result in loss of control and possible serious injury.

4. Accelerate to full throttle and allow brushes to push debris ahead. Sweep to an area where debris can be piled and collected.

NOTICE

Extended use of unit at low throttle settings could cause damage to clutch because of clutch slipping.

5. Debris may be swept out and away from corners by turning unit over to reverse brush direction. Grip unit securely using both hands. Operate throttle trigger with thumb of right hand. For extended use, reposition front handle to allow comfortable grip. Return handle to normal position for regular operation.



WARNING

Turning ProSweep over to reverse sweeper drum rotation will cause debris to be swept toward operator. Reduce engine speed, and be alert for unstable footing caused by loose debris.

When sweeping wide areas, angle brushes to pile debris in rows; then collect material.

- Use an angle of 15-30°. This helps direct debris and reduces operator fatigue.



MAINTENANCE

WARNING

Moving parts can amputate fingers or cause severe injuries. Keep hands, clothing and loose objects away from all openings. Always stop engine, disconnect spark plug, and make sure all moving parts have come to a complete stop before removing obstructions, clearing debris, or servicing unit. Allow unit to cool before performing service. Wear gloves to protect hands from sharp edges and hot surfaces.

Your ECHO unit is designed to provide many hours of trouble free service. Regular scheduled maintenance will help your unit achieve that goal. If you are unsure or are not equipped with the necessary tools, we recommend that you take your unit to an ECHO Servicing Dealer for maintenance. To help you decide whether you want to DO-IT-YOURSELF or have the ECHO Dealer do it, each maintenance task has been graded. If the task is not listed, see your ECHO Dealer for repairs.

Skill Levels

Level 1 = Easy to do. Common tools may be required.

Level 2 = Moderate difficulty. Some specialized tools may be required.

Click [HERE](http://www.echo-usa.com/products/maintenance-kit) or go to <http://www.echo-usa.com/products/maintenance-kit> for information on Maintenance Kits.

Maintenance Intervals

COMPONENT /SYSTEM	MAINTENANCE PROCEDURE	SKILL LEVEL	INTERVAL
Drive Shaft	Grease	1	Every 25 hours of use ¹ .
Gear Housing	Grease	1	Yearly
Brushes	Inspect/Tighten/Replace	1	Before each use
Screws/Nuts/ Bolts	Inspect/Tighten/Replace	1	Before each use

IMPORTANT - Time intervals shown are maximum. Actual use and your experience will determine the frequency of required maintenance.

¹Apply lithium based grease.

Lubrication

Level 1.

Parts Required: Lithium Base Grease.

Gear Housing

1. Clean all loose debris from gear box.
2. Remove plug (A) and check level of grease.
3. Add grease if necessary, DO NOT over-fill.
4. Install plug (A).

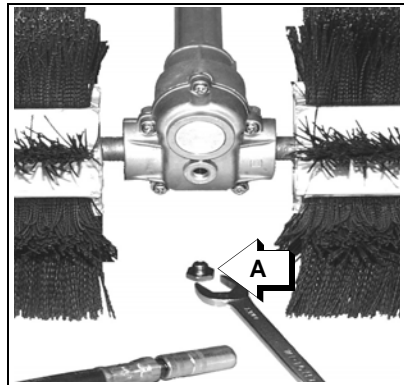

Drive Shaft

NOTICE

Lower and upper drive shaft must be lubricated with lithium based grease every 25 hours of operation, otherwise drive shaft assembly overheating and failure can result.

1. Remove gear housing locator screw (A).
2. Loosen gear housing mounting bolt (B).
3. Pull gear box from drive shaft housing.

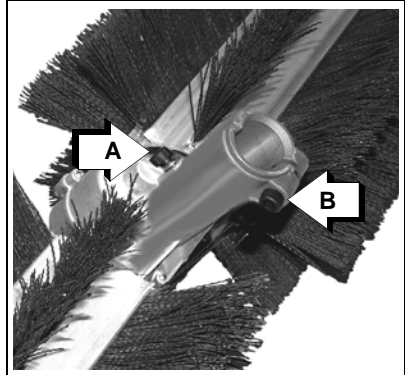

4. Pull flexible cable from the drive shaft housing, wipe clean and re-coat with a thin coating [15 ml (1/2 oz.)] of lithium based grease.
5. Slide the flexible cable back in the drive housing. DO NOT get dirt on the flex cable.
6. Position lower drive shaft (end without safety decal) into gear housing shaft mount.



ENGLISH

- Align hole in drive shaft housing with gear housing shaft hole (C), and seat lower drive shaft end into gear housing shaft mount. Install and tighten locator screw (A).
- Tighten gear housing mounting bolt (B).

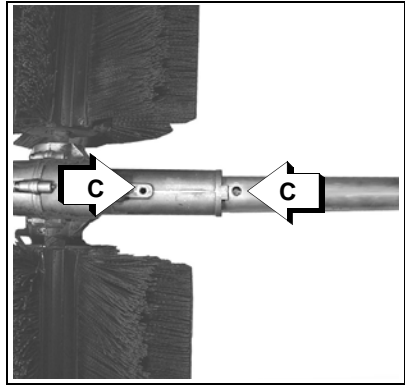

Brush Replacement

Level 1.

Parts Required: Standard Brush Assembly - P/N 99944200551 QTY (2).
Optional Brush Assembly - P/N 25020225661 QTY (2).

Brushes that are broken off, deformed, or worn to within 25.4 mm (1 in.) of the brush holder drum should be replaced for best sweeping efficiency.

- Locate brush holder access hole (A) near outer drum end.

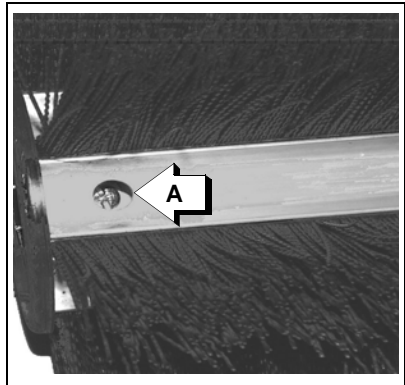

2. Hold 8 mm nut (B) from turning with open end wrench inserted through drum holder cap. Loosen and remove bolt and lock nut with cross head screwdriver through holder access hole (A).
3. Remove drum cap (C). Slide brush holder drum off square axle shaft.
4. Install new brush holder drum, aligning hole (A) in drum axle with axle shaft hole.
5. Install drum cap, aligning cap holes with axle shaft and brush holder drum holes.
6. Install bolt and locknut. Tighten securely.

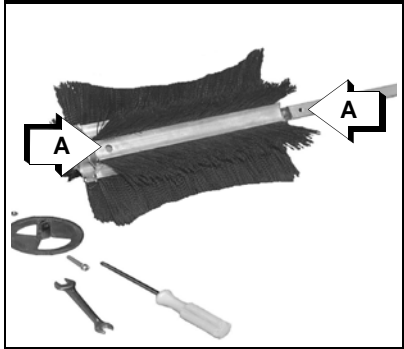
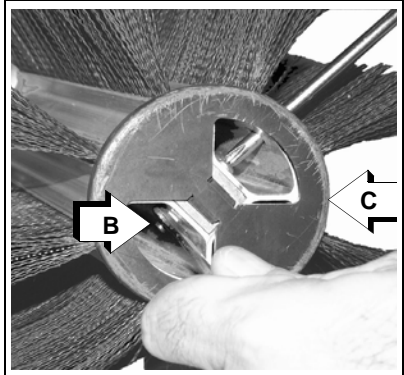

STORAGE

NOTICE

Do not immerse this attachment in water. Water will enter gear housing and damage gears, bearings and seals.

1. Clean ProSweep attachment bristles with water.
2. Apply thin coating of oil to metal parts to prevent rust.
3. Lubricate lower shaft assembly with grease. (Refer to Lubrication instructions).

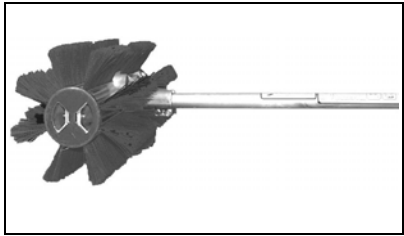

4. Store the attachment in a dry place out of reach of children. Do not store attachment with the weight resting on brushes which could bend over a long period of time. Store attachment with lower shaft housing in a horizontal or vertical position to prevent grease loss from open shaft end.

Storage Hook Installation

1. Insert small end of hook into locating hole on attachment shaft.
2. Slide plastic cap onto end of attachment shaft.



SPECIFICATIONS

ENGLISH

MODEL	99944200553
Attachment Length	925 mm (36.4 in.)
Attachment Width	598 mm (23.5 in.)
Attachment Height	280 mm (11.0 in.)
Weight	5.1 kg (11.25 lb.)
Drive Shaft	6.35 mm (0.25 in.)
Direction of Rotation	Towards the operator viewed from the rear
Brushes	Nylon Bristles 0.7 mm (0.028 in.)
Max Sweeping Width	590 mm (23.2 in.)
Gear Case Lubrication	Lithium Base Grease
Gear Reduction Ratio	42.75 : 1
Sweeper Operating	210 RPM
Engine Wide Open Throttle (with attachment)	7700 - 8500 RPM

PRODUCT REGISTRATION

Thank you for choosing ECHO Power Equipment

Please go to <http://www.echo-usa.com/Warranty/Register-Your-ECHO> to register your new product on-line. It's **FAST** and **EASY!** NOTE: your information will never be sold or misused by ECHO, Inc. Registering your purchase enables us to contact you in the unlikely event of a service update or product recall, and verifies your ownership for warranty consideration.

If you do not have access to the Internet, you can complete the form below and mail to:

ECHO Inc., Product Registration, PO Box 1139, Lake Zurich IL 60047.



PRODUCT REGISTRATION CARD : TARJETA DE REGISTRO : CARTE D'ENREGISTREMENT DU PRODUIT

ONLINE OPTION: Register online and save a stamp! You will be alerted of product updates and/or be sent new ECHO product information and special offers. Simply go to: www.echo-usa.com

OPCIÓN POR INTERNET: Regístrese en la página web y ahorre una estampilla! Le alertarán sobre actualizaciones del producto y/o se le enviará información sobre los nuevos productos ECHO y ofertas especiales. Simplemente visite: www.echo-usa.com

OPTION EN LIGNE: Enregistrer en ligne et épargner un timbre! Vous serez informé sur les nouveaux produits ECHO et les mises à jour de produit ainsi que les offres spéciales. Simplement visitez le: www.echo-usa.com

Please Print : Por Favor Enscriba Con Letra De Molde : En Lettre Carré S.V.P.

Confidential: Information provided will not be shared or sold

Purchaser's Name : Nombre del Comprador : Nom de l'acheteur	
Address : Dirección : Adresse	
City : Ciudad : Ville	Zip Code - Código Postal : Code Postal
State : Estado : Province	
E-Mail Address : Dirección De Correo Electrónico : Courriel Electronique	
Phone Number : Número De Teléfono : Téléphone	Date of Purchase : Fecha de la Compra : Date de l'achat
Where Purchased : Nombre del Almacén donde fue Comprado : Lieu d'achat	
Model Number : Numero del Modelo : No. de modèle	Serial Number : Numero de Serie : No. de série

Registering your purchase enables us to contact you in the unlikely event of a service update or product recall and verifies your purchase. We will never give your name, address or phone number to anyone else. We reserve the right to change or discontinue this service at any time without notice. Please do not provide this information if you do not wish to be contacted. The registration of your purchase is subject to the terms and conditions of the registration card. The registration of your purchase does not constitute an offer of insurance or any other financial product. The registration of your purchase does not constitute an offer of any other financial product. The registration of your purchase does not constitute an offer of any other financial product. The registration of your purchase does not constitute an offer of any other financial product.

Primary use of tool: Professional Homeowner Rental Equip.
 Uso primario de la herramienta: Profesional Dueño de casa Alquiler
 Usage principal: Professionnel Résidentiel Location
 Do you wish to receive periodic ECHO product information and special offers by e-mail? Yes No

¿Desea usted recibir información periódica y ofertas especiales por correo electrónico sobre el producto ECHO? Yes No

Souhaitez-vous recevoir périodiquement de l'information sur les produits ECHO et les offres spéciales par courrier électronique? Oui Non

Did you visit the ECHO website before purchasing your product? Yes No

Visité usted la página web ECHO antes de comprar su producto? Si No

Avez-vous visité le site d'ECHO avant de procurer votre produit? Oui Non

What factor(s) most influenced your purchase?

- Performance
- Price
- Dealer
- Reliability
- Prior Experience
- Quality
- Friend/Family
- Brand
- Warranty

- Funcionamiento
- Precio
- Distribuidor
- Confiabilidad
- Experiencia Anterior
- Calidad
- Amigo/Familia
- Marca
- Garantía

- Performance
- Prix
- Marchand
- Fiabilité
- Expérience
- Qualité
- Amis/Famille
- Marque
- Garantie

ECHO INC., 400 Oakwood Rd., Lake Zurich, IL 60047
 1.800.432.ECHO WWW.ECHO-USA.COM

X7572270206 02-2012

ENGLISH



S08200029000 - S08200999999



ECHO, INCORPORATED

400 Oakwood Road
Lake Zurich, IL 60047

www.echo-usa.com